

AUNF03 Top View 10*10(mm)

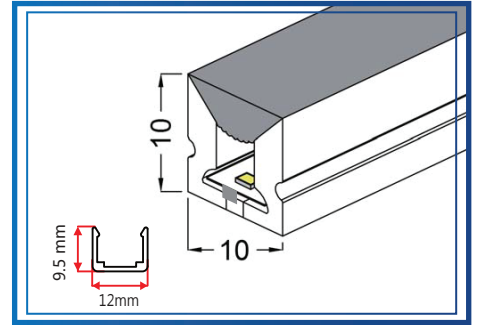

PCB Width(mm)	6
Weight(g/m)	110
Section size(mm)	10*10
Beam angle	120°

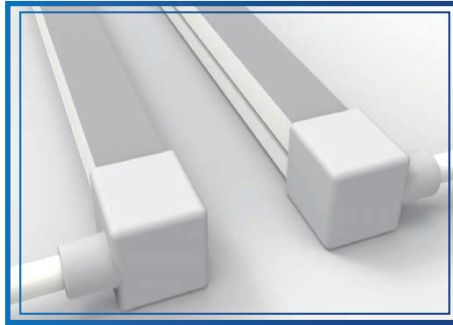
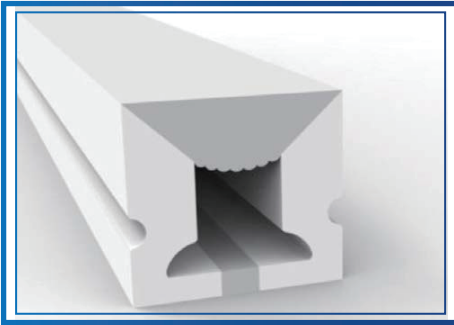
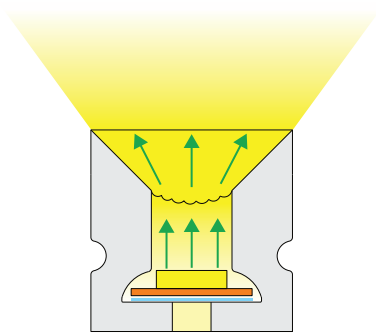

Lighting Dairrection: Top Lighting

Cutting mark:Yes



End cap with hole



End cap no hole



Aluminum Clip



Aluminum Profile



Flexible Profile