

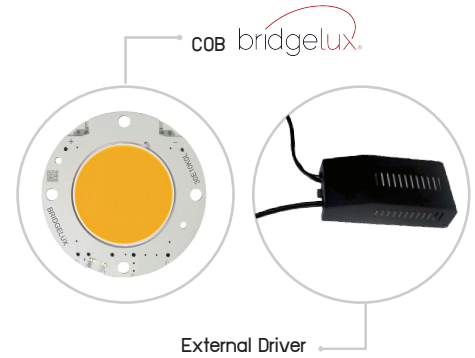

Housing AL. Die-Casting with Electrostatic Powder Coating and **Reflector** AL. Anodized Specular Silver



AU-DLLED-LZ-D3-7101-B20

AU-DLLED-LZ-D3-7101-B30

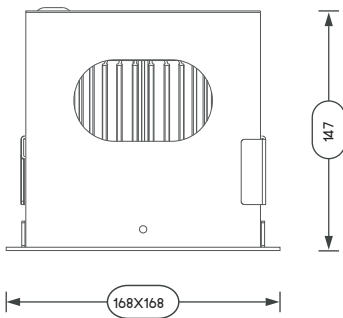

LIGHTING DISTRIBUTION CURVE

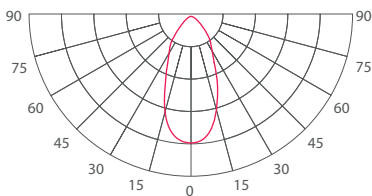

MODEL	AU-DLLED-LZ-D3-7101-B20	AU-DLLED-LZ-D3-7101-B30
WATT	20W	30W
Lamp COLOR	3000K	3000K
LUMEN OUTPUT	1620LM	2000LM
Lamp COLOR	4000K	4000K
LUMEN OUTPUT	1700LM	2080LM
CRI	>80	>80
BEAM ANGLE	45°	45°