

Housing AL. Die-Casting with Electrostatic Powder Coating and Reflector AL. Anodized Specular Silver

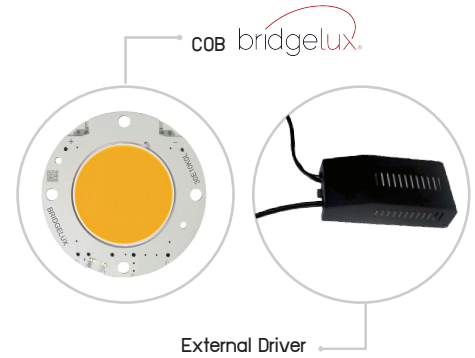

AU-DLLED-LZ-D3-4016-B30

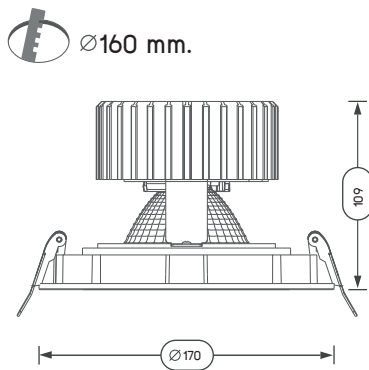

LIGHTING DISTRIBUTION CURVE

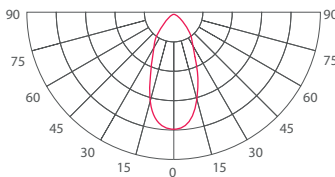

MODEL	AU-DLLED-LZ-D3-4016-B30
WATT	30W
Lamp COLOR	3000K
LUMEN OUTPUT	2000LM
Lamp COLOR	4000K
LUMEN OUTPUT	2080LM
CRI	>80
BEAM ANGLE	50°