

Housing AL. Die-Casting with Electrostatic Powder Coating and Reflector AL. Anodized Specular Silver

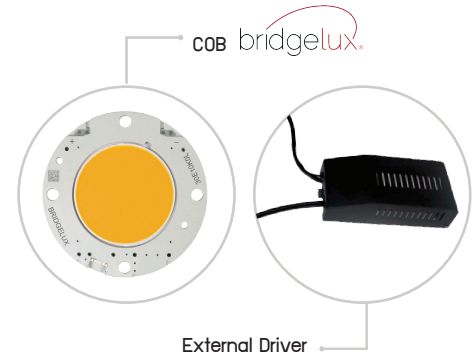

AU-DLLED-LZ-D3-3002-B20

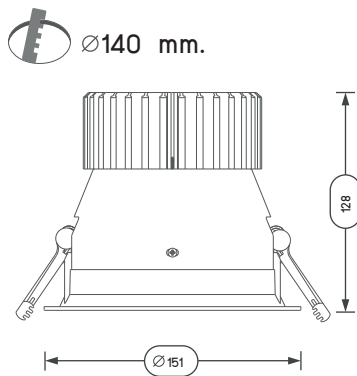

LIGHTING DISTRIBUTION CURVE

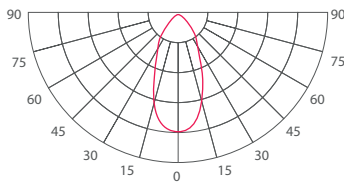

MODEL	AU-DLLED-LZ-D3-3002-B20
WATT	20W
Lamp COLOR	3000K
LUMEN OUTPUT	1620LM
Lamp COLOR	4000K
LUMEN OUTPUT	1700LM
CRI	>80
BEAM ANGLE	45°